

- > 5/2-way
Port size: G1/4, G1/2, 1/4 NPT & 1/2 NPT
 - > Inherently fail-safe without residual pressure
 - > Dynamic self monitoring
 - > Fast exhaust capability
 - > Improves safety and reduces downtime
 - > XSz safety valves are also available as 3/2 way valves
 - > With the appropriate application,
- performance level „e” (cat. 4) of DIN EN ISO 13849-1 is achieved for the safety function “Pressure building up from ‘1’ to ‘2’ and pressure dropping from ‘2’ to ‘3’. DGUV and other approvals
- > Suitable for safety applications with double acting cylinders
 - > Also available with ‘UL-recognized’ solenoids



Technical features

Medium:

Compressed air, filtered ≤ 50 µm, lubricated or non-lubricated

Suitable oils:

Shell Tellus S2 MA 32, ExxonMobil Febis K 32 or comparable oil with DVI values < 8 (DIN ISO 1817) and ISO viscosity class 32-46 (DIN 51519)

Type of control:

Electromagnetic pilot operated, with spool

Flow:

See page 2

Operating Pressure:

XSz8V:
3,2 ... 10 bar (46 ... 145 psi)
XSz10V:
3 ... 10 bar (43 ... 145 psi)

Mounting position:

Preferably upright with solenoids on top

Ambient/Media temperature:

XSz8V:
+2 ... +50°C (+35 ... +122°F)
XSz10V:
-10 ... +50°C (+14 ... +122°F)

For temperatures higher than +35°C (+95°F) we recommend to use lubricated air.

Air supply must be dry enough to avoid ice formation at temperatures below +2°C (+35°F)

Monitoring:

Internal
It is advisable to install a failure indication module to display malfunction messages. For further information please refer to data sheet 5.14.420

Materials:

Body: aluminium
Seals: PUR, NBR

Technical data

Symbol	Series	Pressure range (bar) (psi)	Port sizes			Weight		Drawing No.	Model *1)	NPT thread
			1 (P)	2 (A)	3 (R)	4(B)	(kg)	(lbs)	ISO G thread	
	XSz 8V	3,2 - 10 46 ... 145	1/4	1/4	1/4	1/4	1,5	3,3	1	24928503052 24928703052
	XSz 10V	3,0 - 10 43 ... 145	1/2	1/2	3/4	1/2	2,8	6,1	2	24929823052 24929833052
	XSz 8V *2)	3,2 - 10 46 ... 145	1/4	1/4	1/4	1/4	1,5	3,3	1	24928503048 24928703048
	XSz 10V *2)	3,0 - 10 43 ... 145	1/2	1/2	3/4	1/2	2,8	6,1	2	24929823048 24929833048

*1) To order please insert voltage requested for each valve. All valves are delivered with silencers. Plugs not supplied, see page 2

*2) with UL-recognized solenoid (24 VDC, other voltages on request)

Technical data – solenoids

Model:	3052 and 3048 (UL)
Standard voltages:	24 V d.c. and 230 V a.c., other on request
Duty cycle:	100% ED
Protection class:	IP65
Electrical connection:	DIN EN 175301-803 (DIN 43650), form A & Form B

Circuit diagram

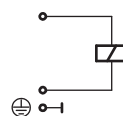

Model	Power consumption V d.c. (W)	Current V a.c. Inrush (VA)	Hold (VA)	Connector
3048	3,7	–	–	Form A
3052	4,8	12	8,5	Form B

Flow rate as per ISO 6358 (CETOP RP 84 P)
XSz 8V

	Port 1 (P) » 2 (A) (m³/h) *3)	2 (A) » 3 (R) (m³/h) *3)	1 (P) » 4 (B) (m³/h) *3)	4 (B) » 5 (S) (m³/h) *3)
Normal cycle	36	112	35	49
Malfunction I *1)	—	71	32	—
Malfunction II *2)	—	80	26	—

*1) Malfunction I: only solenoid 1 switched

*2) Malfunction II: only solenoid 2 switched

*3) Nominal flow volume Q nom. at p1 = 6 bar and Δp = 1 bar

XSz 10V

	Port 1 (P) » 2 (A) (m³/h) *3)	2 (A) » 3 (R) (m³/h) *3)	1 (P) » 4 (B) (m³/h) *3)	4 (B) » 5 (S) (m³/h) *3)
Normal cycle	150	390	160	98
Malfunction I *1)	—	260	120	—
Malfunction II *2)	—	260	150	—

Switching times

XSz 8V measured with 400 cm³ consumer

	Ports	Pressure characteristic	Operating time (ms) *3)		
			24 V d.c. solenoid run at 3,2 bar	6 bar	10 bar
ON position	1 (P) » 2 (A)	rising	169	147	128
	4 (B) » 5 (S)	falling	159	183	203
OFF position	2 (A) » 3 (R)	falling	111	129	142
	1 (P) » 4 (B)	rising	164	161	140
OFF *1)	2 (A) » 3 (R)	falling	124	145	167
Malfunction I	1 (P) » 4 (B)	rising	192	169	145
OFF *2)	2 (A) » 3 (R)	falling	121	143	164
Malfunction II	1 (P) » 4 (B)	rising	181	156	129

*1) Malfunction I: Solenoid 1 only switched off



*2) Malfunction II: Solenoid 2 only switched off

*3) Operating time: From electric ON signal to 90% nominal pressure build-up
 From electric OFF signal until pressure drops to 10% of nominal pressure.

XSz 10V measured with 700 cm³ consumer

	Ports	Pressure characteristic	Operating time (ms) *3)		
			24 V d.c. solenoid run at 3 bar	6 bar	10 bar
ON position	1 (P) » 2 (A)	rising	72	69	69
	4 (B) » 5 (S)	falling	113	127	145
OFF position	2 (A) » 3 (R)	falling	55	64	70
	1 (P) » 4 (B)	rising	74	85	91
OFF *1)	2 (A) » 3 (R)	falling	70	86	126
Malfunction I	1 (P) » 4 (B)	rising	124	154	201
OFF *2)	2 (A) » 3 (R)	falling	70	87	102
Malfunction II	1 (P) » 4 (B)	rising	87	111	129

Accessories

Valve	Connector DIN EN 175301-803	Silencer	Integrated silencer
			
Series			
XSz 8V	0680003 / UL: 0570275	MB002B (G 1/4)	—
	0680003 / UL: 0570275	MB002A (1/4 NPT)	—
XSz 10V	0680003 / UL: 0570275	MB004B (G 1/2)	0016422
	0680003 / UL: 0570275	MB004A (1/2 NPT)	0016422

Note: The security is dependent on the quality of the silencer, use only original Norgren silencer!
 All solenoids are delivered without connectors. If connectors are necessary, please order them separately.

The double-acting valve is a system which meets the requirements of Safety Category 4 (self-monitoring control devices), provided that the actuating solenoids are controlled in conformity with Safety Category 4. If the double-acting valve is used in conjunction with an electric two-hand control, the actuating solenoids must be controlled by an output signal from a Type III C electric two-hand control as per DIN EN ISO 13849-1 if Category 4 has been selected as a result of a risk assessment. If the double-acting valve is used to control dangerous movements in an electropneumatic system then the pneumatic control commands used to control the actuating solenoids, the connection lines and any downstream control units must comply with the safety category selected on the basis of a risk assessment.

Description of the 5/2 way valve

Like the 3/2-way safety valve, the 5/2-way safety valve consists of two mechanically separated pilot control systems and main valve systems. The valves are solenoid operated. The design of the main valve system is such that, in rest position, port 2(A) is vented and port 4(B) is pressurised.

The valves are solenoid operated. The design of the valve is such that port 2(A) will only be depressurised and port 4(B) will only be vented if:

- a) both command signals arrive at the same time within a time delay <0.1 s (synchronous actuation)

Owing to its type of construction, the double-acting valve cannot prevent an elevated load from descending slowly in the event of a power failure or the power being disconnected. If a power failure or a disconnection of power can cause a dangerous movement, then additional devices may be required (e.g. spring-loaded clamping devices, pilot-controlled non-return valves) depending on the risk assessment and the safety category selected on the basis of that risk assessment.

The 5/2-way double-acting valve is not suitable for the control of clutch and brake on mechanical presses.

- b) both spindles were previously in rest position
- c) both spindles move into switching position within the given time delay.

Failure:

In the event of a fault on one of the two systems (e.g. mechanical blockage), the pressure will fail to build up on port 2 (A) and port 4 (B) will remain pressurised upon restart (provided that the operating pressure is present on port 1 (P)).

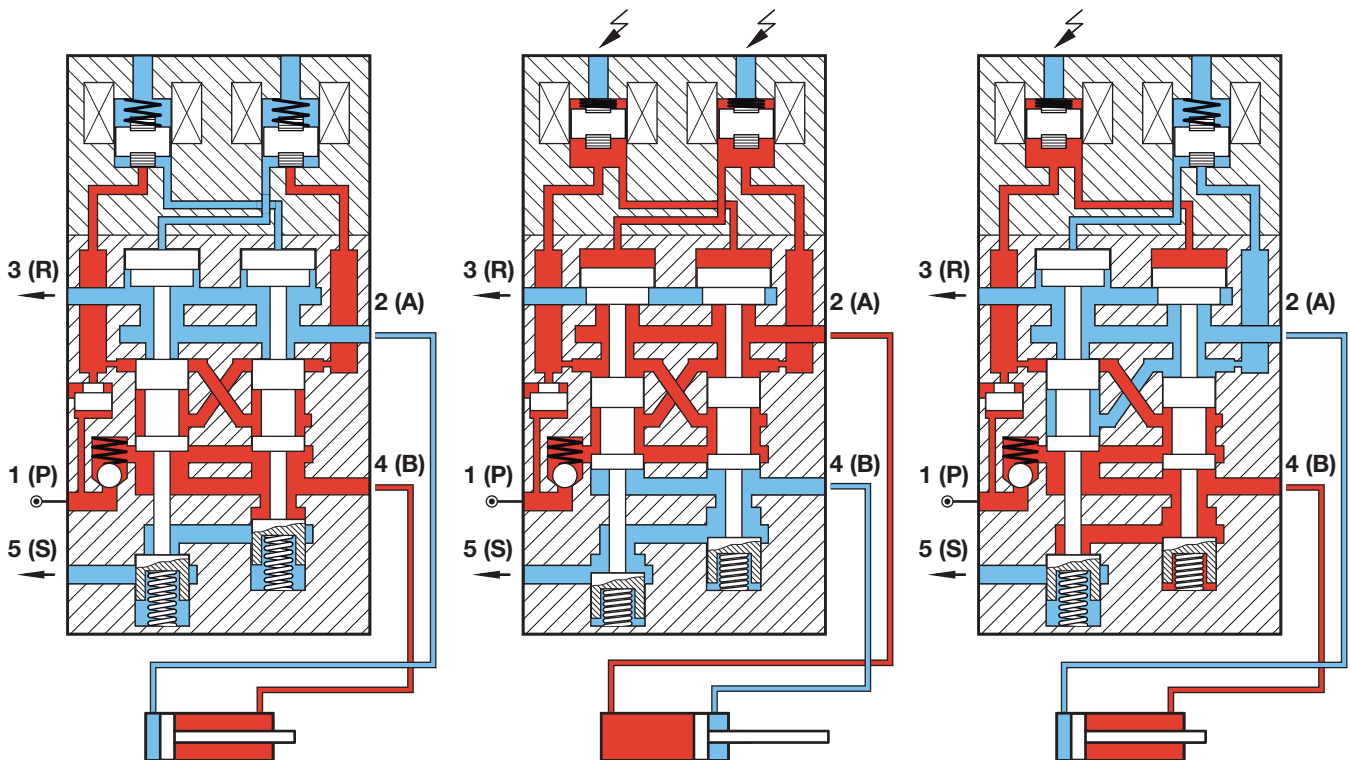

Solenoids de-energized

Port 2 (A) is vented via port 3 (R). Port 4 (B) is connected to pressure port 1 (P).

Solenoids energized

The solenoids are energized simultaneously. Process port 2 (A) is connected to pressure port 1 (P). Port 4 (B) is vented via exhaust port 5 (S). Each valve system is self-monitoring and checks for correct functioning upon each switching operation (dynamic monitoring).

Malfunction

The solenoids are energized non-synchronously. The dynamic monitoring system detects the time delay in actuation and prevents pressure from building up on process port 2 (A). Port 4 (B) remains connected to 1 (P) port so as to prevent, for example, the upper tool of the press from descending.

1

XSz 8V – with silencer

Dimensions in mm
 Projection/First angle

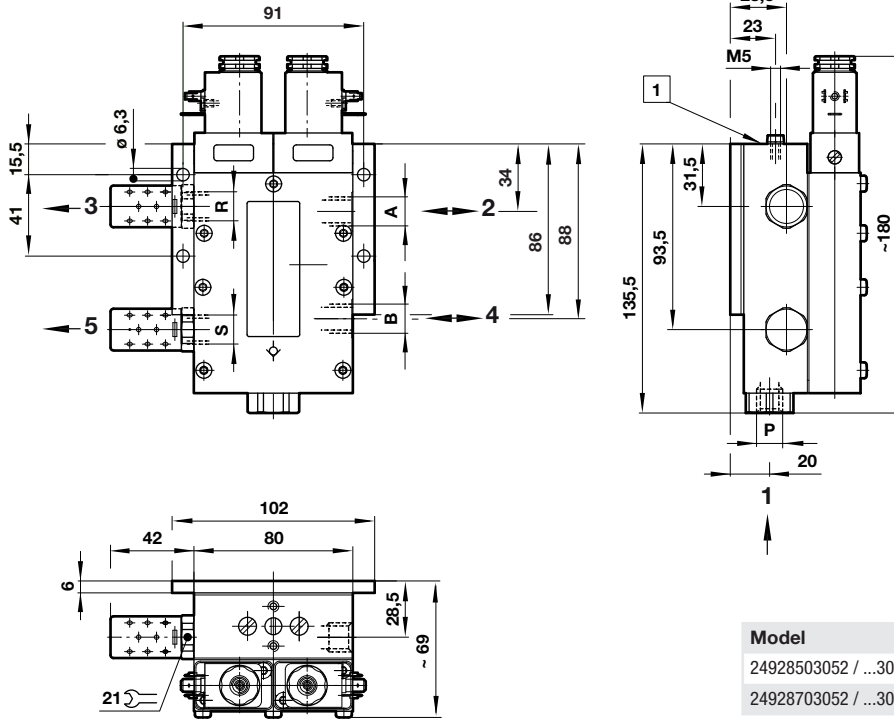

2

XSz 10V – with silencer

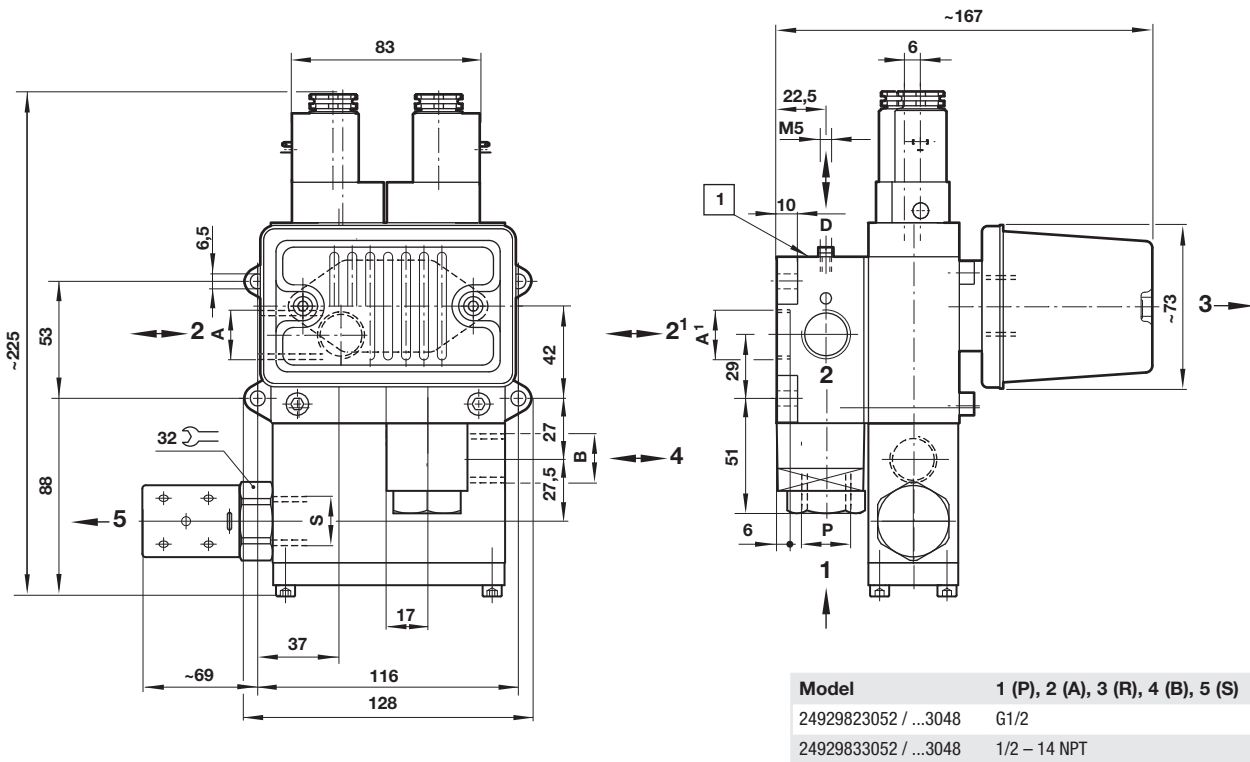

1 Mounting interface for pressure switch and failure indication module.

* sealed with plug

For external indication (e.g. visual, electrical or acoustic signal) of a malfunction, the installation of a failure indication element is recommended. Such an element is not necessary to fulfil the safety function of the valve. (For further information please see the corresponding data sheet no. 5.14.420).

A suitable air treatment unit (dehydration, filtration, lubrication) must be connected upstream of pressure port 1 (P). Lubrication can only be omitted if the connected consuming device and all additional equipment is suited for oil-free operation. Degree of filtration: 50 µm. The lubrication should be adjusted to supply only enough oil to form a film on the valve spool and bore. Excessive lubrication may cause a build-up of oil in the pilot lines and cause sluggish operation of the valves.

The size of pressure regulator, lubricator and filter must be consistent with the inlet port size. An accumulator tank is recommended between the pressure regulator and safety valve. The operating pressure must not drop below the minimum operating pressure indicated on the name plate and the use of a pressure switch is suggested.

Attention: Uncontrollable elements, such as quick exhaust valves, nozzles and non-return valves may not be installed between the press safety valve and clutch brake.

It is the responsibility of the purchaser and/or installer of the Norgren safety valves to make sure that the valve and all other components comply with all relevant national regulations and the specifications of the local safety associations.

The valves should be checked at intervals depending on the loads to which they are subjected, at least, however, once a year. The relevant tests must be carried out according to the corresponding operation and maintenance instructions of the unit and the local safety regulations. In case of malfunctions the unit has to be tested and/or replaced immediately. Repairs and maintenance must only be carried out by the after-sales service of the valve manufacturer or by a qualified engineer trained by the valve manufacturer.

Important for use at presses:

The combination with the electrical press control must meet the DIN EN ISO 13849-1 requirements.

All liability is denied for unauthorised modification of the units, installation or usage not in accordance with the manual, the local safety requirements and the principles of DIN EN ISO 13849-1.

These products are intended for use in industrial compressed air systems only. Do not use these products where pressures and temperatures can exceed those listed under

»Technical features/data«.

Before using these products with fluids other than those specified, for non-industrial applications, life-support systems or other applications not within published specifications, consult IMI Precision Engineering, Norgren GmbH. Through misuse, age, or malfunction, components used in fluid power systems can fail in various modes.

The system designer is warned to consider the failure modes of all component parts used in fluid power systems and to provide adequate safeguards to prevent personal injury or damage to equipment in the event of such failure.

System designers must provide a warning to end users in the system instructional manual if protection against a failure mode cannot be adequately provided.

System designers and end users are cautioned to review specific warnings found in instruction sheets packed and shipped with these products.